

Technical Drawing

Desenho Técnico

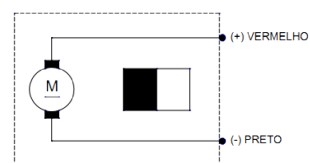
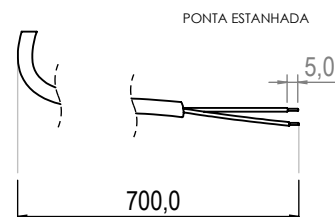
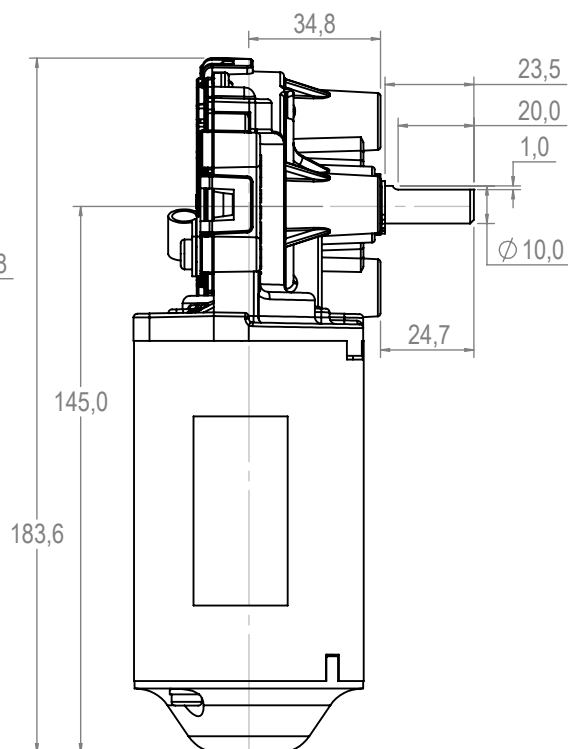
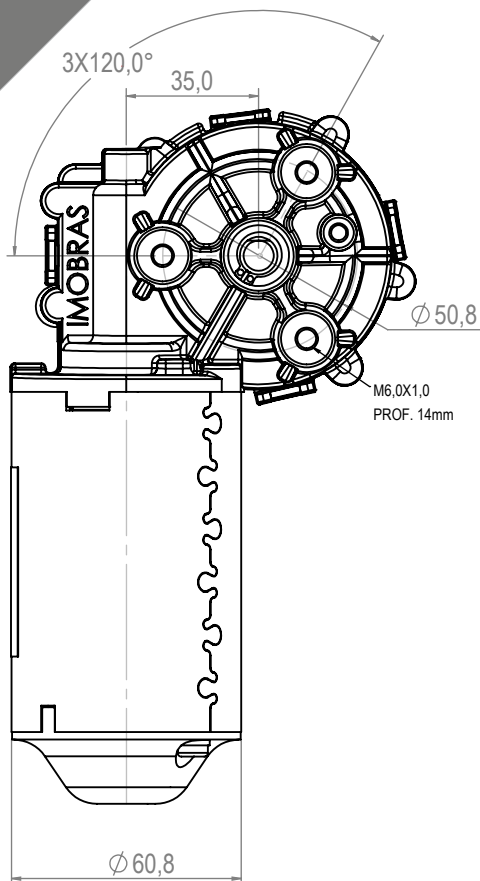

Technical Specification

Especificação Técnica

Imagem Ilustrativa

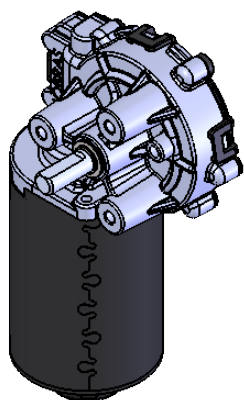

**100403924**

CARACTERÍSTICAS ELÉTRICAS	
U N (V)	27
P N (W)	30
n N (rpm)	45
I N (A)	2,5
I max (A)	21
M N (Nm)	6
M max (Nm)	30
i	63:1
Rotação	L/R
Peso (Kg)	1,500

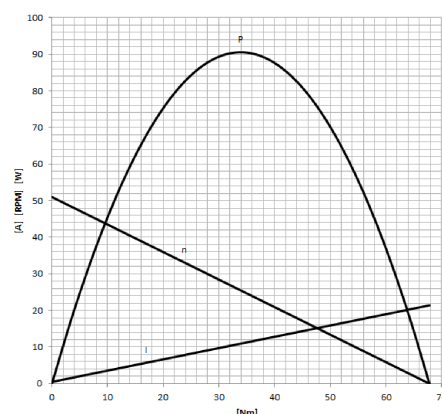

NOTAS:

Aplicação: Industrial

NOTES:

Application: industrial